

Creative Shaping Cushion

Supplies:

Cream Velvet $\frac{5}{8}$ yd (0.55 m) cushion top

Grey Satin $\frac{7}{8}$ yd (0.75 m) cushion

White Cotton $\frac{3}{4}$ yd (0.7 m) cushion form

Cotton Batting $\frac{3}{4}$ yd (0.7 m) cushion form lining

Rayon Thread 40 wt

Rayon Thread 30 wt for the embroidery

Bobbin Thread

Sewing Thread

Invisible Zipper 22" (55 cm)

Tear-away stabilizer

Sulky Totally Stable

Fusible Webbing

Tracing Paper

Water soluble marker

Polyester stuffing

Sensormatic/ Embroidery Foot 820671-096

Invisible Zipper Foot 820479-096













$\frac{1}{4}$ " Right Guide Foot 820541-096

Open-Toe Appliqué Foot,
9mm with IDT 820213-096

1 Cutting Instructions:

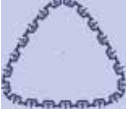
- Tracing Paper: 1 – 20" (50 cm) diameter circle pattern piece
 1 – 16" (40 cm) diameter circle pattern piece
- Cream Velvet: 1 – 20" (50 cm) square
- Grey Satin: 1 – 22" (56 cm) square cut in half (cushion back)
 1 – 21" (50 cm) square (cushion front)
 2 – 2 ½" (6.5 cm) strips x width of fabric (cushion side)
- White Cotton: 2 – 20" (50 cm) circle (cushion form)
 2 – 2 ½" (6.5 cm) strips x width of fabric (cushion form side)
- Cotton Batting: 2 – 20" (50 cm) circle (cushion form lining)
 1 – 2 ½" x 62" (6.5 x 159 cm) strip (cushion form side lining)

2 Assembly Instructions:

1. Using the Shaping feature on your Pfaff creative vision sewing machine you will design the embroidery designs used on this cushion.
2. Go to Embroidery Mode 
3. Open the Selection Menu and choose the Stitches Menu 4. Select Decorative stitch 4.5.29 (crown). 
5. Open Shaping 
6. Open the Shape selection pop-up 
7. Select the triangle shape. 
8. Use the arrows in the wheel to increase the size to 113 x 100 mm. 
9. Add 20 copies by touching the duplicate last icon. For a total of 21 crowns.
10. Close the Shape selection pop-up.
11. Touch select control points 
12. Select the outer points. 
13. Use the slider and set the attraction to 53%.
14. Close Shaping and save your design and name it Triangle. 
15. Open the Selection Menu again and choose the Stitches Menu.
16. Select Decorative stitch 4.3.8 (leaves)
17. Open Shaping 
18. Open the Shape selection pop-up 
19. Select the flower shape. 
20. (Select the touch function – scale.) Use the arrows in the wheel to increase the size to 165 x 160 mm.
21. Add 20 copies by touching the duplicate last icon. For a total of 21 repeats.
22. Close Shaping and save your design and name it flower. 

23. On the cream velvet 20" (50 cm) square mark the center cross point with a water soluble marker. Then draw diagonal lines from corner to corner. Measure 5 1/2" (13.5 cm) out from the center point on all the lines and make a mark. Connect the marks to form two squares as shown on the diagram below. These will be your placement lines for embroidery.

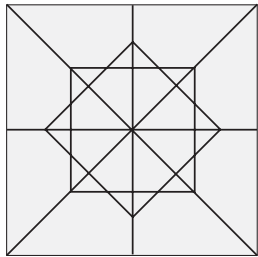

24. Hoop stabilizer. Position the flower you created in Shaping in the center of the square. Using Precise Positioning to center the design on the center marked lines. Baste in place.
25. Embroider the flower design using 30 weight Rayon thread in the top and bobbin thread in the bottom.

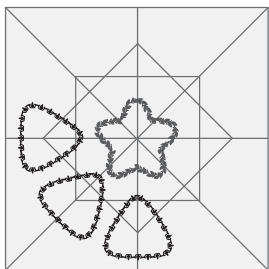

26. Hoop another piece of stabilizer and position the triangle you created in Shaping in the bottom half of the square, use Precise Positioning to center on the marked lines. Baste in place and embroider.
27. Continue embroidering the triangle design around the flower using the positioning lines.

28. Remove the stabilizer.
29. Fuse fusible webbing to the wrong side of the embroidered square.
30. Center the 16" (40 cm) diameter circle pattern piece on the embroidered square and cut out the circle. Remove the paper from the fusible webbing and set aside.
31. Iron Totally Stable to the wrong side of the grey satin 21" (50 cm) square.
32. With the water soluble marker draw a line down the center of the square. Thread your machine with light grey 40 wt rayon thread and choose a decorative stitch. Attach the Open Toe Applique foot. Stitch down the drawn line.

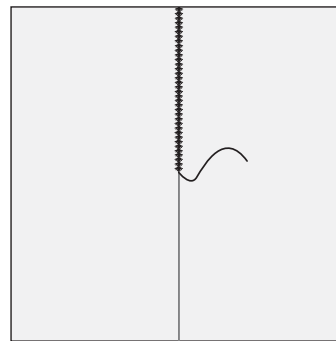

33. Choose another decorative stitch. Place the edge of the foot along the previous stitched line and sew. Continue to embellish the entire square with decorative stitches. Remove the stabilizer. Press.
34. Center the 20" (50 cm) diameter circle pattern piece on the embellished square and cut out the circle.
35. Center the 16" (40 cm) embroidered circle on the 20" (50 cm) embellished circle. Press in place.
36. Fuse Totally Stable stabilizer onto the wrong side of the grey satin.
37. Thread your sewing machine with beige rayon thread on top and bobbin thread in the bobbin. Satin stitch around the beige velvet circle to attach it to the grey satin circle. Remove the stabilizer.
38. Zipper Insertion: Use the cushion back pieces 2 – 11" x 22" (28 x 56 cm) grey satin.

Thread your sewing machine with sewing thread in the top and bobbin, attach the invisible zipper foot and select a straight stitch.

39. Open the zipper and place the right half of the zipper onto the 22" (56 cm) right cushion back piece, with the right sides of the zipper and fabric together. The coil should lie on the 1/4" (6 mm) seam line, starting 5/8" (1.5 cm) below the upper edge of the fabric. Pin in place. The bottom of the zipper will extend beyond the fabric.

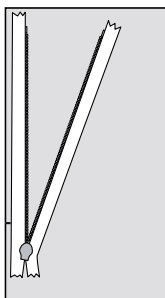

40. Carefully press the teeth slightly to the right and lower the zipper foot, so that the coil lies in the groove to the right of needle.
41. Starting at the top, sew the zipper in place, stopping at the end of the fabric. Tie-off the end of the seam.
42. Place the second zipper tape on the left side of the cushion back piece. Make sure that both coils and fabric edges are level.
43. Pin the zipper in place. Open the zipper.
44. Carefully press the teeth slightly to the left and lower the zipper foot, so that the coil lies in the groove to the left of the needle.
45. Starting at the top, sew the zipper in place, stopping at the end of the fabric. Tie-off the end of the seam. Close the zipper.
46. Place the 20" (50 cm) circle pattern piece on

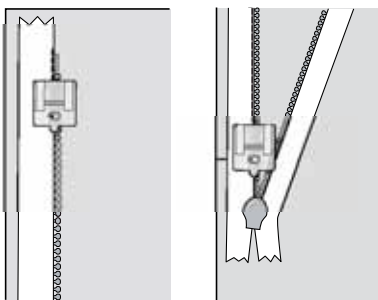

the back piece. Line up the top edge of the pattern with the zipper pull and center the zipper. Draw the circle on the back piece. Before cutting out the circle, sew over the end of the coil with a straight stitch to act as a zipper stop 1/4" (6 mm) up from the drawn line. Stitch across the top to join the fabric pieces together, for ease of sewing into the seam of the cushion. Cut out the circle. Open the zipper enough to turn the cushion through after the back and top is sewn together.

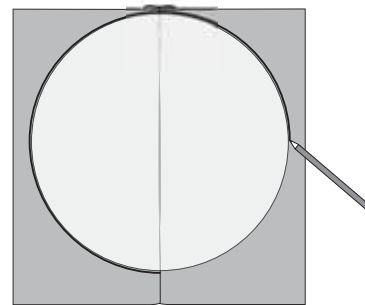

47. Attach the 1/4" Right Guide Foot. Seam together the 2 1/2" (6.5 cm) strips using a 1/4" (6 mm) seam allowance. Press the seam open. Cut the strip into a 62" (159 cm) piece. Sew the cushion side strip into a circle.
48. Fold the cushion side into quarters and mark those points. Fold the cushion top into quarters and mark those points. Match the quarter points and pin the top and side pieces with right sides together. Sew using a 1/4" (6 mm) seam allowance.

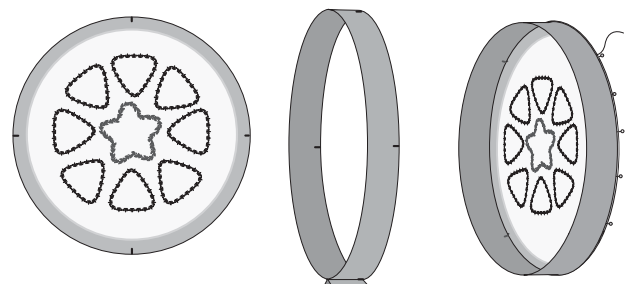

49. Fold the cushion back into quarters and mark those points. Match the quarter points and pin the back and side pieces with right sides together. Sew using a 1/4" (6 mm) seam allowance.
50. Turn right side out.

51. Cushion Form is made up of the following pieces.

- Cotton 2 – 20" (50 cm) circle
- 2 – 2 ½" (6.5 cm) strips x width of fabric
- Batting: 2 – 20" (50 cm) circle
- 1 – 2 ½" x 62" (6.5 x 159 cm) strip

Place the cotton 20" (50 cm) circle on top of the batting circle and baste together. Repeat for the remaining circle.

52. Seam together the 2 ½" (6.5 cm) cotton strips using a ¼" (6 mm) seam allowance. Press the seam open. Cut the strip into a 62" (159 cm) piece. Sew the side strip into a circle. Stitch the batting to the side strip butting up the batting ends.

53. Fold the side piece into quarters and mark those points. Fold the circles into quarters and mark those points. Match the quarter points and pin the circles and side pieces with right sides together. Sew using a ¼" (6 mm) seam allowance. Leave an opening for turning.

54. Stuff the cushion with the polyester stuffing. Stitch the opening closed.

55. Open the zipper in the cushion back and insert the cushion form.

Finished!